

Article number: 03441070

Description: Fluro Rod end GE 70EC-2RS

Measures

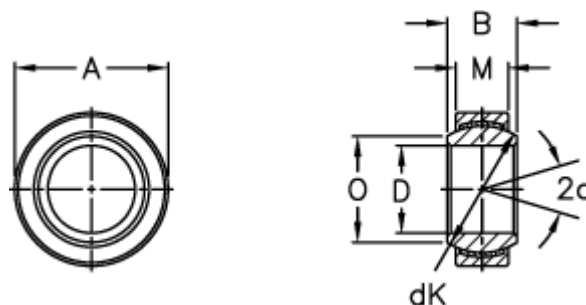

A = 105 0 -0,015

B = 49

D = 70 0 -0,015

dK = 92

Dynamic load C (kN) = 590

M = 40

O = 77.8

Static load C0 (kN) = 1180

Tilt angle = 6

Weight = 1500